

TWE - SC3400

Heavy-Duty Stud Welding System Operations Manual



The SC3400 is a fully integrated stud welding system with two digital controls for time and current. The system was designed to meet the most challenging stud welding jobs to include weld thru-deck applications (this also includes G90 decking).

TRU-WELD EQUIPMENT COMPANY

6400 N. Honeytown Road

Smithville, Ohio 44677

(330) 669-2773 Phone

(330) 669-2473 Fax

TWE@tfpcorp.com

<http://truweldstudwelding.com>



TRU-WELD EQUIPMENT LIMITED WARRANTY

All goods produced by Tru-Weld Equipment shall be warranted against defects including workmanship and components. No other warranties whether expressed, verbal, or implied will apply. Warranties only apply to the original equipment purchaser.

Warranty claims will be limited to either repair or replacement of the defective materials by Tru-Weld Equipment. At the option of Tru-Weld Equipment the location of where the warranty evaluation and repairs are made will be determined. All warranty claim items returned to Tru-Weld Equipment will be at the customer's expense. At the option of Tru-Weld Equipment the defect will either be repaired or replaced. Notice must be provided to Tru-Weld Equipment of a warranty defect within 30 days that the defect or failure is incurred. Warranties are not transferable.

This warranty does not apply for equipment which is used improperly in any fashion including but not exclusive to the following:

Equipment which has been modified

Equipment which has not been installed properly

Equipment which has been used for purposes other than which it had been designed

Equipment which has not been properly maintained

Equipment which was continued to be used after a defect had been found

Equipment which was damaged in any way

Tru-Weld Equipment will never be liable for consequential damages, loss, or expense occurring directly or indirectly from the use of the equipment covered in this warranty.

All cables, cable sets and connectors are not warranted.

Two (2) year warranty period from date of purchase

SC3402 Power Supply

SC3400 Power Supply

SC2402 Power Supply

SC2400 Power Supply

SC1600 Power Supply

SC1400 Power Supply

TWE250 Power Supply

TWE321 Power Supply

TWE375 Power Supply

One (1) year warranty period from date of purchase

TWESPC Power Supplies

TWP-2 Power Supply

Ninety Day warranty period from date of purchase

(Excluding cables and connectors)

TWE70000 HD Arc stud gun

TWE18500 MD Arc stud gun

TWE19000 LD Arc stud gun

TWEG CD stud gun

TWEHDG Heavy Duty CD stud gun

Table of Contents

Section	Description	Page
1.0	Cover	1
2.0	Table of Contents	2
3.0	Company Profile and Product Information	3
4.0	Safety Precautions	
4.1	Safety Precautions - Symbols and Description	4
4.2	Safety Precautions - Electric Shock	5
4.3	Safety Precautions - Welding Sparks	6
5.0	Product Specifications	7
6.0	SC3400 Setup and Installation	
6.1	SC3400 Setup and Installation - Initial Steps	8
6.2	SC3400 Setup and Installation - Power Diagrams	9
6.3	SC3400 Setup and Installation - Primary Power	10
6.5	SC3400 Setup and Installation - Ground Cable Connections	11
6.6	SC3400 Setup and Installation - Control Cable Connections	12
7.0	SC3400 Operations - Stud Gun Setup	
7.1	Stud Gun Setup - Initial Steps	13
7.2	Stud Gun Setup - Lift Adjustment	14
7.3	Stud Gun Setup - Plunge Adjustment	15
7.4	Stud Gun Setup - Cable Connections	16
8.0	SC3400 Operations - Settings	
8.1	SC3400 Operations - Unit Power/Diagnostic Lights	17
8.2	SC3400 Operations - Setting Time and Current	18
8.3	SC3400 Operations - Setting Job Counter	19
9.0	SC3400 Operations - Welding	
9.1	Step by Step	20
9.2	Tips and Suggestions	21
9.3	Weld Inspection and Adjustments	22
10.0	Troubleshooting	23, 24
10.1	Troubleshooting - Chart A	25
10.2	Troubleshooting - Chart B	26
11.0	Parts and Accessories	27

Company and Product Information

Company Profile

Tru-Weld Stud Welding has been making weld studs since 1959, and since 1970 we have been producing our own line of high-quality stud welding equipment. Tru-Weld is located in Medina, Ohio and has product and equipment distributors across the nation. Tru-Weld Equipment Company (TWE) offers a full line of Drawn-Arc and Capacitor Discharge (CD) stud welding equipment, replacement parts, and accessories.

Our experienced Management and Staff is committed to provide the utmost in quality and service in every step of our production, while remaining competitive in the marketplace. It is our goal to meet our customer's needs more effectively than our competitors through a process of continuous quality improvement. Our long-standing relationship with our customers' and suppliers' is our key to continued success and growth. If we can be of any further assistance to you and your company, please do not

Product Information

The SC3400 is a fully integrated stud welding system with two digital controls for time and current. The system was designed to meet the most challenging stud welding jobs to include weld thru-deck applications (this also includes G90 decking).

Features:

- ◆ Enhanced duty cycle for production requirements and powerful output for even the largest diameter jobs.
- ◆ Digital time and current control allow for infinite settings for fine tuning the welding output.
- ◆ Safety welding interlock keeps system from double triggering and saves on chuck wear.
- ◆ Stud Job counter which can be reset per job.

Complete system Includes:

Power supply controller, TWE17000 heavy duty stud gun, 50ft of 4/0 weld and control cable and 25ft of 4/0 ground cable w/ HD clamp.

Stud Welding Safety Precautions

Safety is everyone's responsibility. TRU-WELD designs every machine with safety in mind, and a safe work environment depends largely on you.

Do not install, operate, or repair this equipment without carefully reading this manual and observing all of the safety precautions mentioned. If there is a question, ask your supervisor!

Safety Symbols

Every effort has been made to protect trained operators from injury or unnecessary risk. Certain symbols are used throughout this manual to call attention to safety-related information and instruction. The safety symbols in this manual have these meanings:



This symbol indicates Dangerous Situations. When this symbol is used in this manual, death or serious bodily harm is possible or probable if the corresponding preventative measures are not taken. Operators must take caution in the method and manner of handling or using the machine when this symbol is displayed.

Safety Precautions

Do not install, operate, or repair the SC3400 welding equipment without reading this manual and all safety precautions stated within!

This machine was designed and built with operator safety in mind, but safety begins with you! Every effort has been made to protect the trained operator from injury. Please become familiar with the information in this manual to minimize the risk of shock or injury.



STUD WELDING CAN BE HAZARDOUS. ALWAYS PROTECT YOURSELF AND OTHERS FROM POSSIBLE INJURY OR DEATH. KEEP CHILDREN AWAY.

Operators who have a pacemaker should consult with their physician before operating stud welding equipment.

FUMES and OXYGEN DEPLETION

- ◆ Only weld in areas or rooms where adequate ventilation of weld gases is possible and where there is not fire, smoke or explosion hazards.
- ◆ When working in a confined space always have trained support personnel nearby.
- ◆ Welding fumes and gases can displace air and lower the oxygen level causing injury or death. Be sure the breathing air is safe.
- ◆ Do not weld in locations near degreasing, cleaning, or spraying operations. The heat and rays of the arcs can react with vapors to form highly toxic and irritating gases.
- ◆ Do not weld on coated metals, such as galvanized, lead, or cadmium plated steel. The coating must be removed from the area to be welded. Coatings and metals containing above elements can generate toxic fumes when heated to welding temperature.

Stud Welding Safety Precautions

ELECTRIC SHOCK



Electric shock can injure or kill!

Precautionary measures must be taken to provide maximum protection against electrical shock.

- ◆ Do not touch live or energized electrical parts or store metallic objects near power.
- ◆ Ground the work or metal to be welded to a good electrical (earth) ground.
- ◆ Do not leave an energized machine unattended.
- ◆ Never work in wet clothing, gloves or footwear.
- ◆ Insulate yourself from work and ground using dry insulation. Make certain the insulation is large enough to cover your full area of physical contact with work and ground.
- ◆ Inspect all system components, protective equipment, cables, connectors and gas lines prior to operating equipment. Never use cables that are longer than necessary.
- ◆ When testing a live unit, use the one-hand method. Do not put both hands inside of the unit. Keep one hand free.
- ◆ Disconnect input power conductors from de-energized supply line before moving a welding power source.
- ◆ Always be sure the work cable makes a good electrical connection with the metal being welded. The connection should be as close as possible to the area being welded.
- ◆ Turn OFF welding power source before servicing unless the procedure specifically requires an energized unit.



- ◆ Never touch the energized stud or gun before discharging the stud to ground.
- ◆ Never use the power source to provide heat for thawing frozen pipes.

ARC RAYS and EYE PROTECTION

Arc rays can injure eyes and burn skin.

Arc flashes are painful.

- ◆ Use a shield with the proper filter and cover plates to protect your eyes from sparks and the rays of the arc when welding or while observing open arc welding.
- ◆ Use protective clothing specifically intended for work with welding equipment. It should be made of durable flame-resistant material to provide ample protection from the arc rays.
- ◆ Protect other nearby workers with suitable, non-flammable screening. Caution other workers not to watch the arc nor expose themselves to the arc rays or to hot spatter or metal.

Stud Welding Safety Precautions

WELDING SPARKS



Heat from flames and arcs can start fires. Hot slag or sparks can also cause fires and explosions.

Remove all combustible materials from the work area or cover these materials with a protective non-flammable tarp. Combustible materials include wood, fabrics, sawdust, liquid and gas fuels, solvents, paints and coatings, paper, etc. Hot sparks or hot metal can fall through cracks or crevices in floors or wall openings and cause a hidden smoldering fire. Make certain that such openings are protected from hot sparks and metal.

ELECTRIC and MAGNETIC FIELDS

Electric current flowing through any conductor causes localized Electro-Magnetic Fields (EMF). Welding and cutting current creates EMF around welding cables and welding machines.

- ◆ Operators having pacemakers should consult their physician before welding. EMF may interfere with some type of pacemakers.
- ◆ Exposure to EMF may have other health effects, which are unknown.
- ◆ Operators should use the following procedures to minimize exposure to EMF:
- ◆ Route the work cables together. Secure them with electrical tape when possible.
- ◆ Never coil the work cable around any part of your body.
- ◆ Do not place your body between the work cables. Route cables on the same side of your body.
- ◆ Connect the work cable to the work piece as close as possible to the area being welded.
- ◆ Keep welding power source and cables as far away from your body as possible.
- ◆ Electromagnetic fields can irrevocably erase magnetic data carriers (computer memory, credit cards, security ID cards or data storage diskettes).
- ◆ Electromagnetic fields may magnetize and damage watches or similar digital devices.

PROTECT YOURSELF and OTHERS!



Some welding, cutting, and gouging processes are noisy and require ear protection. The arc, like the sun, emits ultraviolet (UV) and other radiation and may injure skin and eyes. Hot metal can cause burns. Training in the proper use of welding processes and equipment is essential to prevent accidents.

- ◆ Always wear safety glasses with side shields in any work area. In conjunction with eye protection, welding helmets or face shields are also required.
- ◆ Use a face shield fitted with the correct filter cover plates to protect your eyes, face, neck, and ears from sparks and rays of the arc when operating or observing operations. Warn bystanders not to watch the arc and not to expose themselves to the rays of the electric arc or hot metal.
- ◆ Wear flameproof type gloves, heavy long-sleeve shirt, cuff less trousers, and a welding helmet or cap for hair protection, to protect against arc rays and hot sparks or hot metal. A flameproof apron may also be desirable as protection against radiated heat and sparks.
- ◆ Hot sparks or metal can lodge in rolled up sleeves, trouser cuffs, or pockets. Sleeves and collars should be kept buttoned, and open pockets eliminated from the front of clothing.

SC3400 Product Specifications

Weld Range	1/4" to 1"	Consistent welding regardless of stud diameter.
Duty Cycle	1/4" thru 5/8" 3/4" 7/8" 1"	Unlimited 22 to 24 per minute 16 to 18 per minute 12 to 14 per minute
Dimensions	Height Width Length Weight	28" (736.6mm) 29" (711.2mm) 36" (914.4mm) 875 Lbs. (397kg)
Input Voltages		230 / 460 / 575 VAC 3 Phase 60Hz 400 VAC 3 Phase 50Hz
Fusing Requirements	(Slow acting)	230 / 200 Amps 400 / 100 Amps 460 / 100 Amps 575 / 90 Amps

Features

Smooth Arc Curve allows for a wide range of welding.

Enhanced Duty Cycle for production requirements.

Powerful output for even the largest diameter welding projects.

Time and current control allow for infinite settings for fine-tuning the welding output.

Safety welding interlock keeps system from double-triggering.

Equipped with a Stud Job Counter that can be reset for every job or project.

On-Demand Fan that cycles on and off when needed.

** Specifications are subject to change without prior notification.

SC3400 Setup and Installation

Initial Steps



Only qualified personnel should perform this installation.

- ◆ Turn the input power off at the disconnect switch or fuse box before working on the welder.
- ◆ Do not touch electrically hot parts.

This section provides detailed instructions for the proper installation of the TWE SC3400. It is recommended that these instructions be followed carefully to allow for the best possible operating environment.

Handling and Unpacking the Welder

Immediately upon receipt of the welder, inspect the shipment for any damage and notify the carrier of such damage before accepting delivery. Then inspect welder for damage which may have occurred in transit. After removing the components from the shipping container(s), check the container for any loose parts. Remove all packing materials. Visually check all air passages of power source for any packing materials that may obstruct airflow through the welder. If the equipment is not being installed immediately, store it in a clean, dry, well-ventilated area until installation.

Selecting a Location

The location of the power source should be carefully selected to ensure satisfactory and dependable service. Choose a location relatively close to a properly fused source of electrical power. Use care against toppling over if the machine is placed on a tilted surface or plane. It is important that the machine be located in an open area where air can circulate freely through the front and rear openings. If space is at a premium, leave at least 1 foot (300 mm) of clearance between the rear of the power source and wall or other obstruction.

Electrical Input Requirement

The welding power source is designed to be operated from three-phase, 50Hertz, AC power supply. Consult your local electrical utility if you have any questions on the electrical system at the present installation site. The SC3400 should be operated from a separate, fused or circuit-breaker protected circuit.

SC3400 Setup and Installation

Power Connection Diagrams

Electrical Input Requirement

The SC3400 is equipped with an Input Voltage Jumper Block so you can operate the unit from different line voltages depending on your requirements. These settings should be checked to see if they are properly positioned for the voltage being used.

- ◆ Cross the terminals on the Jumper Block with the jumper (Figure 1) and tighten down the hold down nuts.
- ◆ Use the schematic below for the jumper setting to suit your line voltage requirement

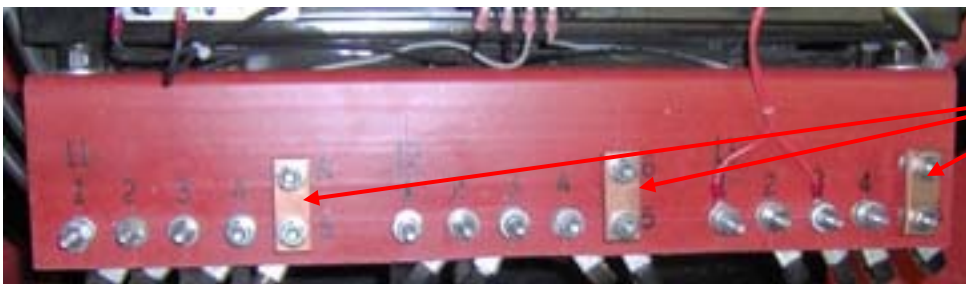

Jumpers

Figure 1 - Jumper Block

230VAC

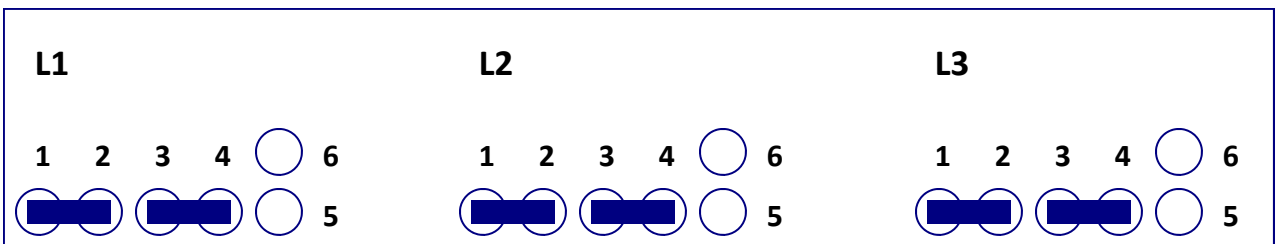

460VAC

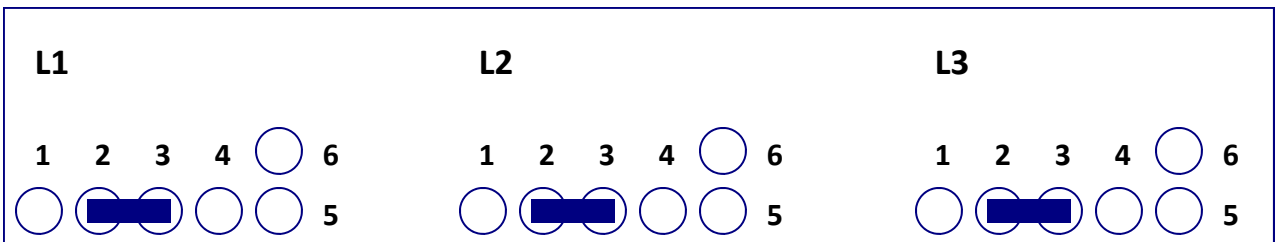

575VAC

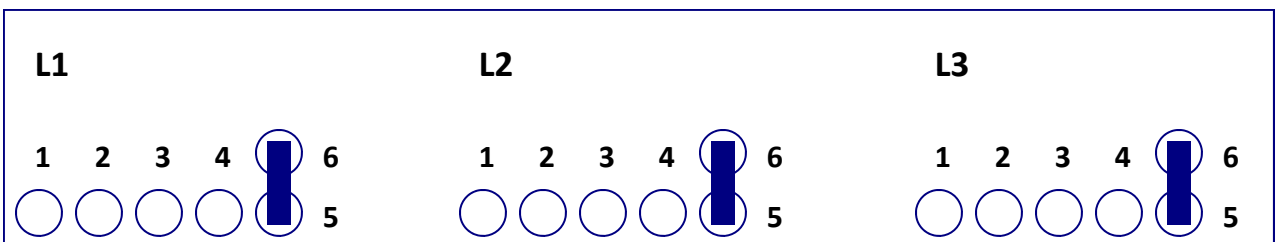

SC3400 Setup and Installation

Preparing the Unit for Primary Power



Only qualified personnel should perform this installation.

- ◆ Turn the input power off at the disconnect switch or fuse box before working on the welder.
- ◆ Do not touch electrically hot parts.

Remove the top cover of the SC3400. All of the connections that will need to be made are accessible with the top cover removed.

Primary Power Cable and Ground Connection

- ◆ Route the Primary Power Cable through the Power Inlet Hole (see Figure 2) in the top left corner on the backside of the welder, giving enough slack to reach the terminal block .
- ◆ Connect the Ground Wire to the frame of the welder as shown in Figure 1.
- ◆ Connect the power leads (Black, White, Red) to the L1, L2, and L3 connectors on the terminal block, as shown in Figure 1.

Figure 1

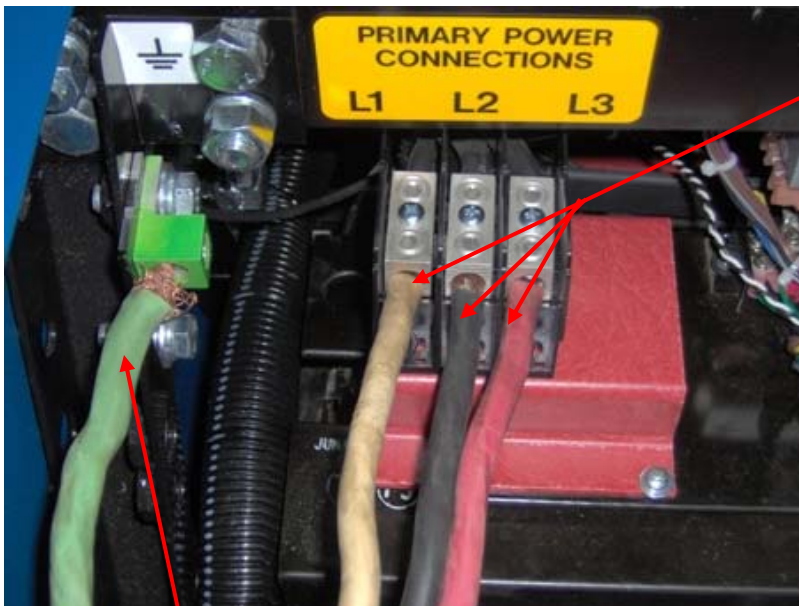

Ground Connection

Power Connections

Figure 2



Route primary power cable through power inlet hole and tighten down clamp.

SC3400 Setup and Installation

Ground Cable Connections

- ◆ The SC3400 is equipped with two ground cable connections located in the front of the welder (lift access panel).
- ◆ Tighten ground cable to welder and secure other end to work surface using the Heavy-Duty C-Clamp (see Figure 2).

Figure 1 - Front of SC3400

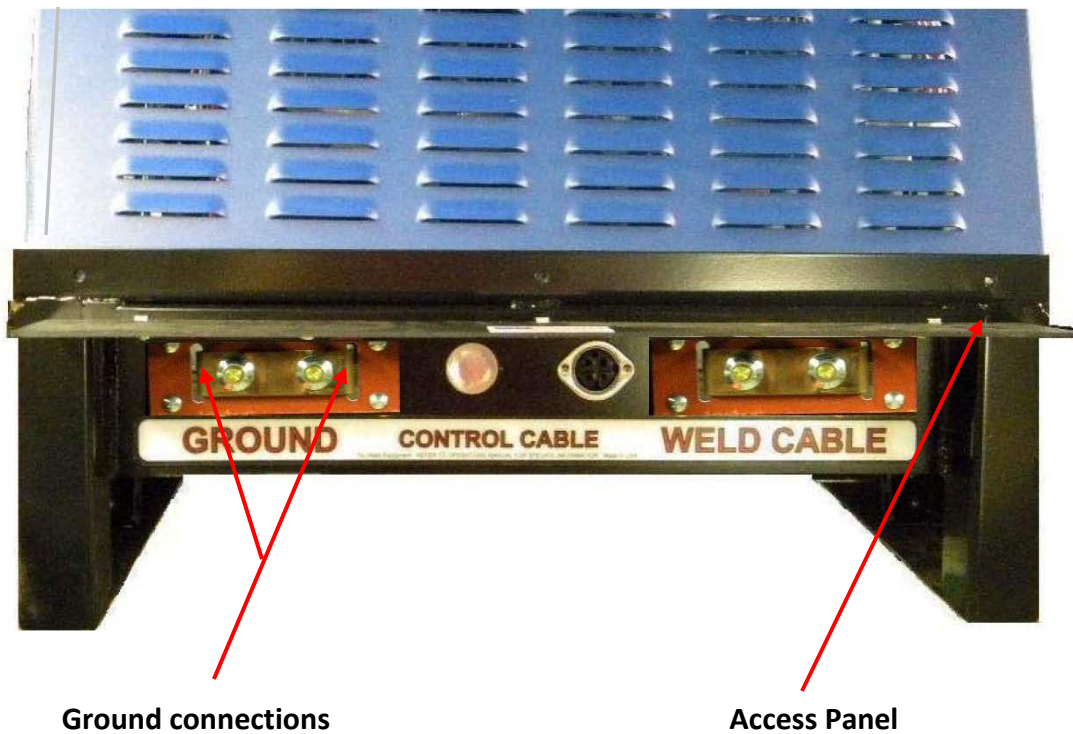
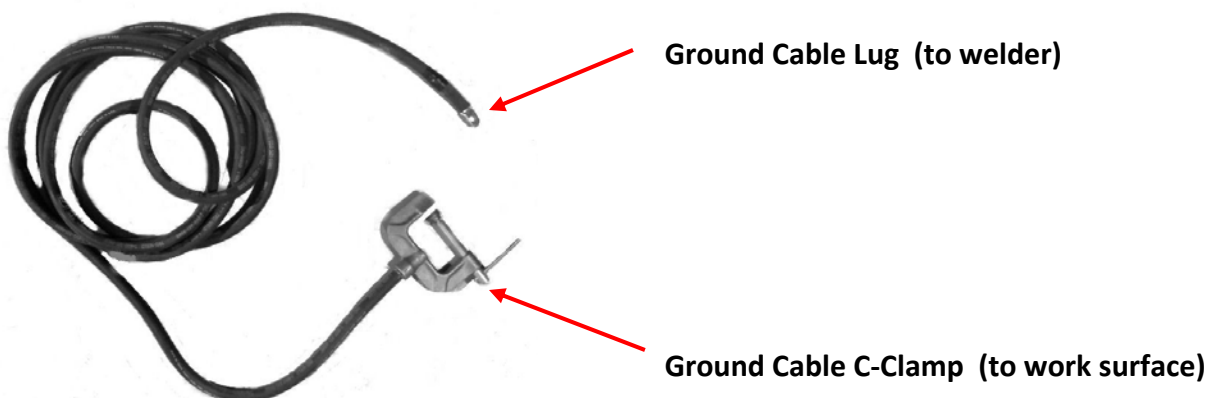

Figure 2 - Ground Cable



SC3400 Setup and Installation

Weld Cable Connections

- ◆ The SC3400 is equipped with two weld cable connections located in the front of the welder (lift access panel).
- ◆ One end of the cable assembly connects directly to the SC3400 and the other end connects to the cabling from the weld gun. The welder end will have a cable lug on the Heavy Duty 4/0 Weld Cable and a male 4-pole plug on the Control Cable.
- ◆ Tighten weld cable lug to welder .
- ◆ Plug Control Cable plug into port on bottom front of welder (lift access panel). The Control Cable has a male 4-pole connector on one end that plugs into the port.

Figure 1 - Front of SC3400

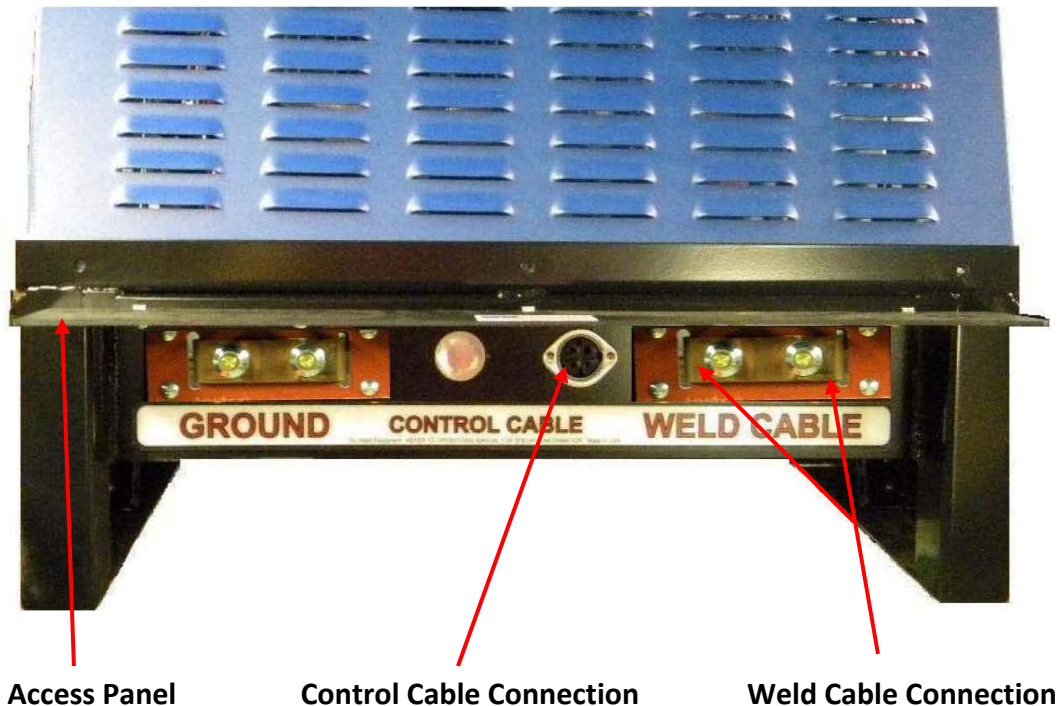

After the cables are connected to the welder, it is time to configure your weld gun for its specific job. Once the gun is configured and set up properly, the gun cables will connect to the weld cables. For the SC3400, the weld cable ends that connects to the Heavy-Duty TWE17000 Stud Gun will be a female Control Cable Plug and a female Heavy-Duty High Temperature camlock connector.

Stud Gun Setup

Stud Gun Setup

Each stud welding application requires that the stud gun be set up properly for the correct stud and ferrule arrangement.

- ◆ Select the correct style and size of chuck for the stud to be welded and attach it to the stud gun.
- ◆ Select the proper length leg assemblies for the length of the stud.
- ◆ Select the proper foot piece best suited for your application.
- ◆ Select the grip to fit the ferrule which is provided with the stud to be welded.

After all of the proper accessories have been mounted on the stud gun place the stud in the chuck and begin the alignment of the accessories.

- ◆ Make certain that a sufficient amount of the stud is inserted in the chuck so that the stud is held firmly.
- ◆ Attach the ferrule to the ferrule grip.
- ◆ Plunge setting; move the leg, foot and ferrule assembly so that the stud protrudes beyond the ferrule (1/8" for studs 1/2" and under in diameter 3/16" for studs up through 7/8" and 1/4" for 1" diameter studs).
- ◆ Position this assembly so that the stud moves freely through the ferrule when you slide the shaft of the stud gun back and forth.

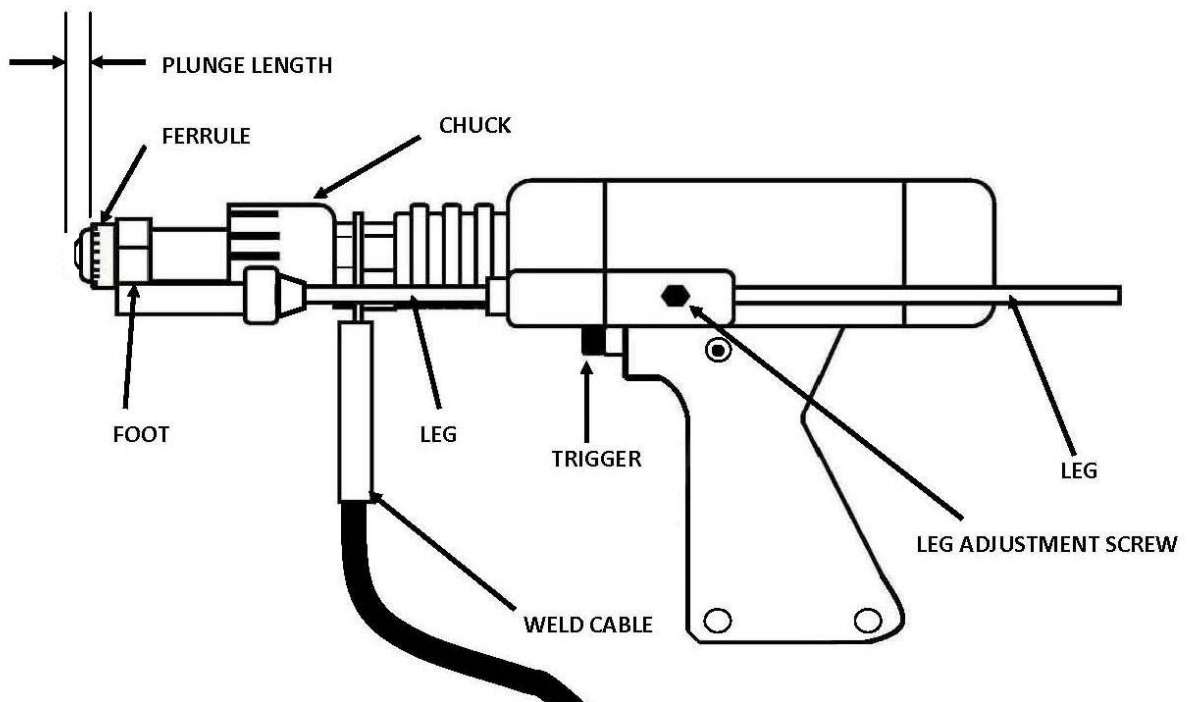

Stud Gun Setup

Lift

Set the lift when all of the accessories and stud have been properly set on the stud gun, prior to welding. Plug the control connector of the stud gun directly into the stud welder (do not attach the weld cable). Turn on the stud welder and actuate the trigger of the stud gun with the stud and ferule in place. Note the retraction of the shaft of the stud gun. This is designated as the Lift.

The lift setting should be about $3/32$ " for general welding applications and studs ranging in diameter through $3/4$ " this adjustment should be suitable. For larger diameter studs and select applications the lift should be adjusted to approximately $1/8$ ".

Adjusting the lift:

- ◆ Remove the back cap of the stud gun.
- ◆ Loosen the two socket set screws around the periphery of the lift adjustment screw.
- ◆ To increase lift rotate the lift adjustment screw counter clockwise and to decrease lift rotate clockwise.
- ◆ With each turn check the lift by actuating the stud gun until the desired lift is achieved.
- ◆ Tighten the socket set screws to hold the lift adjustment screw in place to secure the selected setting.
- ◆ Replace the back cap of the stud gun.

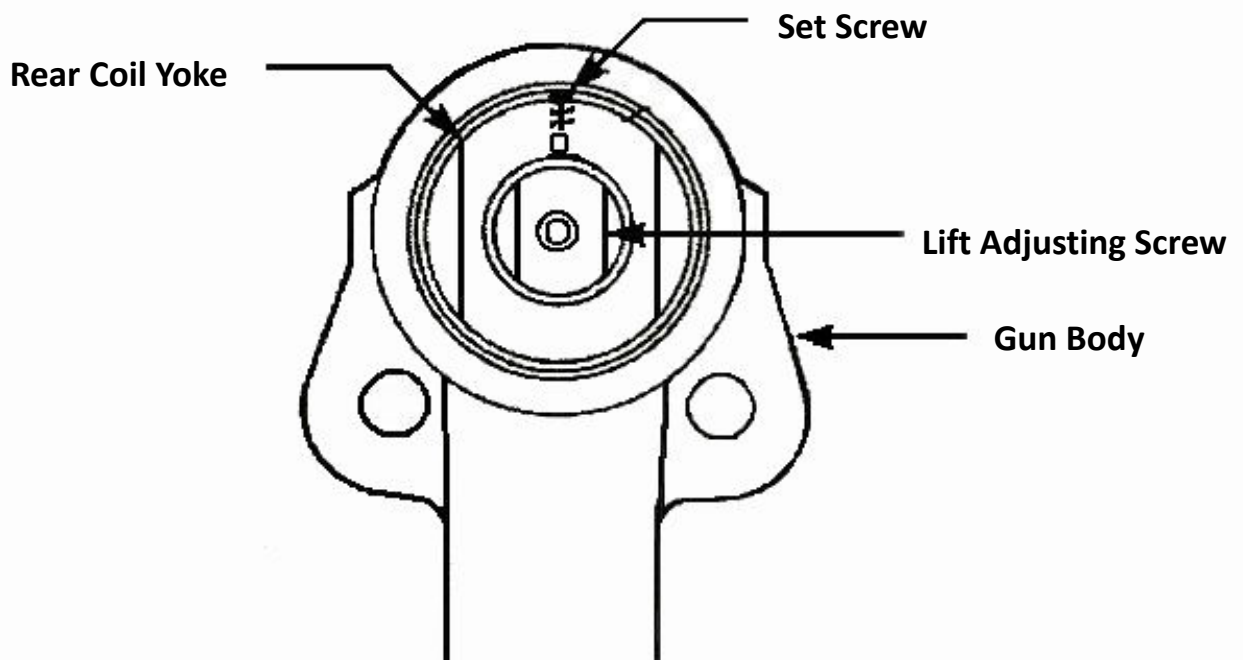

Stud Gun Setup

Free Travel Adjustment

This adjustment can be used to control the force with which the stud is plunged into the molten weld pool by moving the engagement point of when the shaft of the stud gun engages the dampener.

Rotating the dampener cover counter clockwise increases the amount of free travel.

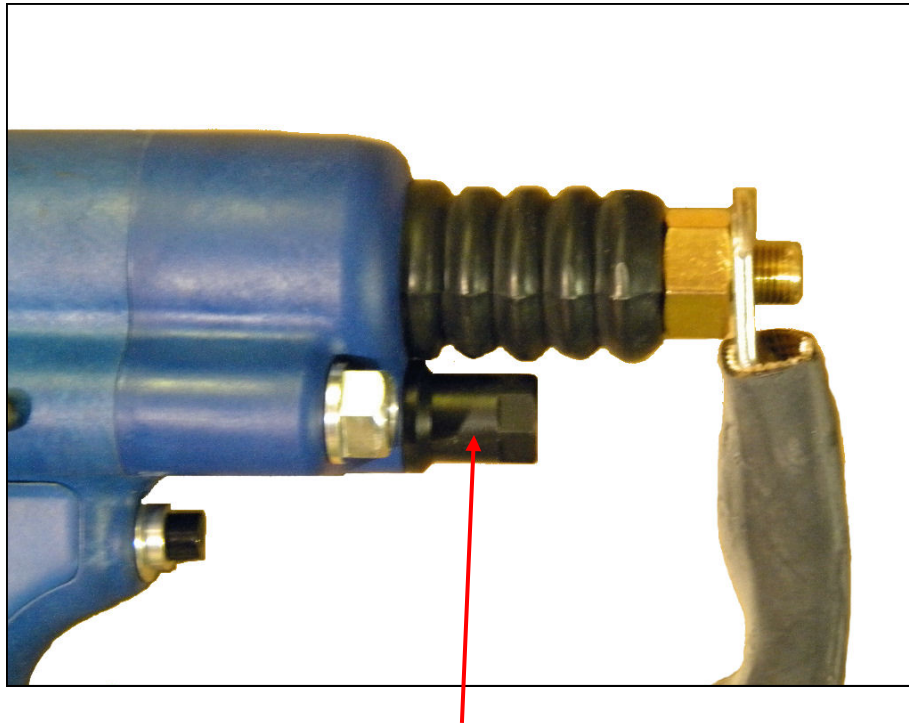

Dampener Cover

TWE17000 Heavy-Duty Weld Gun



TWE18500 Medium-Duty Weld Gun



Stud Gun Setup

Attaching the stud gun to start welding

- ◆ Select the gun, control cable, and weld cable that is recommended for the specific type of welder and the job.
- ◆ Attach stud gun to weld and control cable extension.
- ◆ Actuate the stud gun without placing it on the surface to be welded to assure that the connection through the control cable is correct to complete the circuit and actuate the stud gun.
- ◆ Make sure welder is set up properly to begin the welding process.
- ◆ Place the selected stud into the chuck and attach the ferrule to the ferrule grip.
- ◆ Place stud onto surface to be welded and press stud gun down until ferrule is flush with the welding surface.
- ◆ Trigger the gun and hold in place until cycle is completed.
- ◆ Pull gun assembly straight up off of the welded stud.
- ◆ Do not depress trigger when removing gun from stud.
- ◆ Remove the ferrule by breaking it off and inspect the weld.
- ◆ Make proper adjustments as needed.

Figure 1 - TWE17000 Heavy-Duty Stud Gun

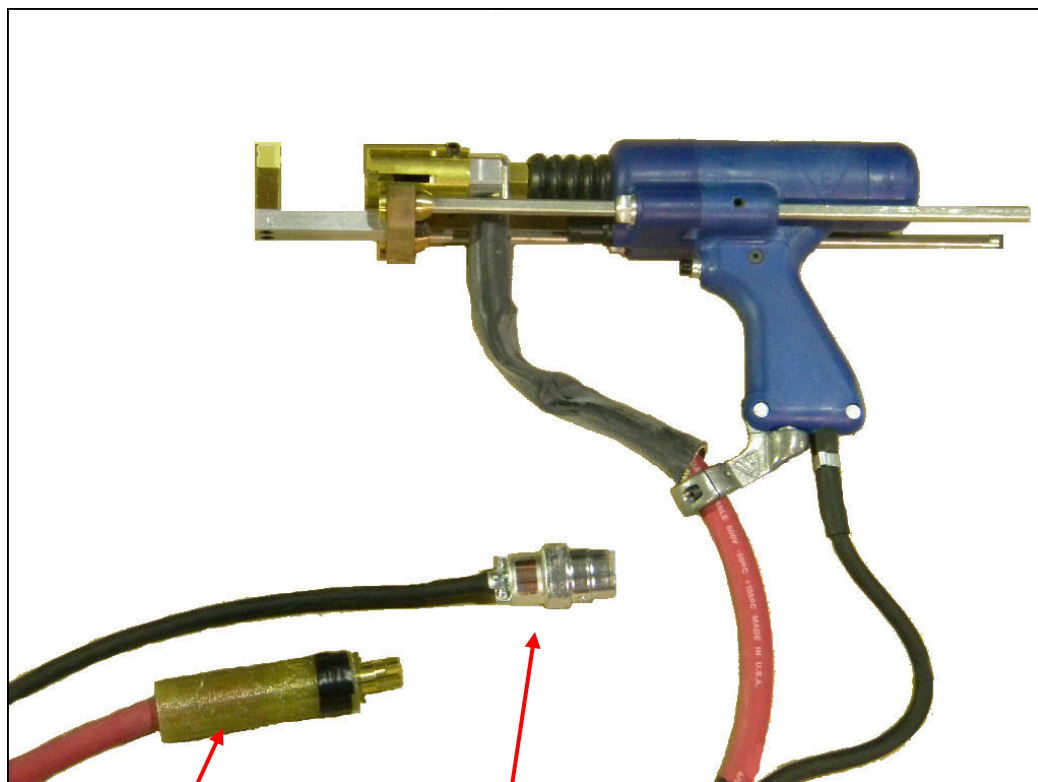

Male Camlock End

Control Cable Plug

SC3400 Operations - Settings

SC3400 Power Switch/Power On

The power switch for the SC3400 is located on the right front of the welder's control panel. Off position is vertical with the "O" showing. On position is horizontal with the "I" displayed.

When the welder is turned on, the digital display will go through a self-diagnostic check. This takes approximately 3 to 5 seconds, and then the digital display will show the last time and current setting.

This denotes that the unit is ready to go.

When connected to the welder, the stud gun will actuate 3 times, indicating that there is a good connection.



SC3400 Diagnostic Lights

On the Control Panel, located below the digital display, is a row of diagnostic lights for the welder.

OUTPUT - When the stud gun is triggered, this light comes on to indicate that the OCV is present at the output terminals.

TRIGGER - When the stud gun is triggered, this light comes on to indicate that the trigger circuit is functioning properly, and that the welding unit is receiving feedback from the stud gun.

POWER - When this light is lit, it indicates that there is an error.

TEMP - When this light is lit, it indicates that either the main transformer or weld bridge has reached maximum temperature and that the unit will not function until it is cooled.

REMOTE - This function is not currently in use.

Diagnostic Lights

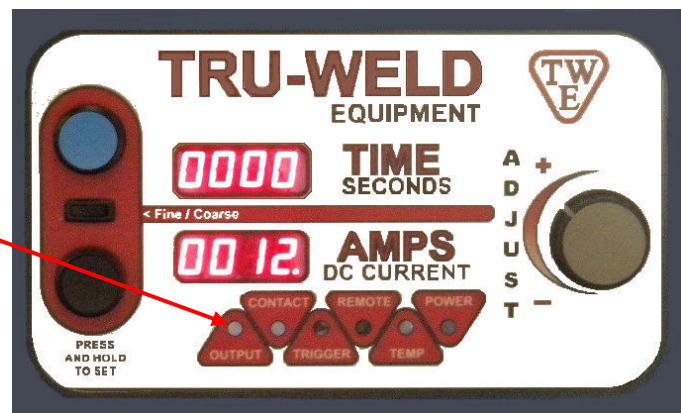

SC3400 Operations - Settings

Setting Welding Controls - Time and Current

The time and current controls are located on the front of the welder. The controls consist of a Time Button, Current Button, Adjustment Dial, and a Fine/Coarse Switch. The digital display will indicate the settings chosen during setup.

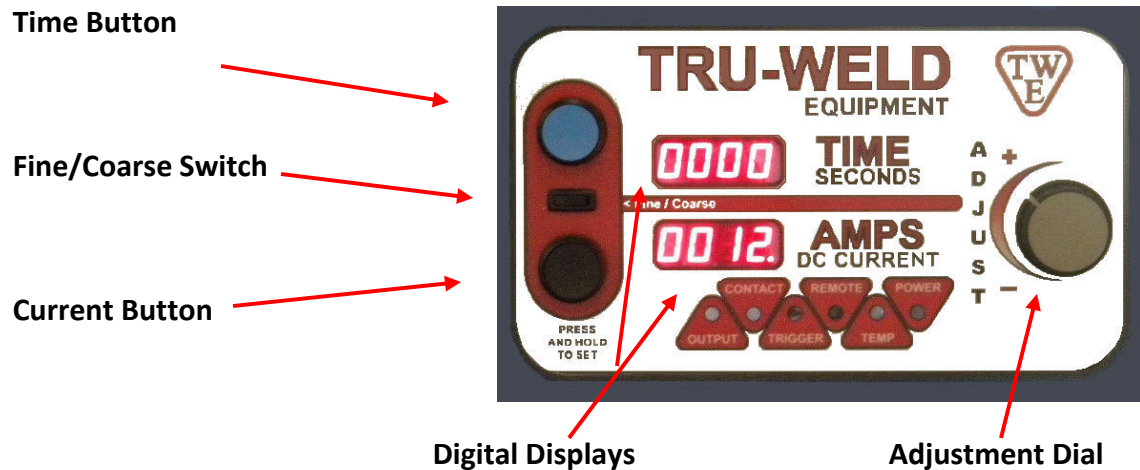

- ◆ When setting time or current, depress and hold down appropriate button, and turn Adjustment Dial clockwise or counter-clockwise to the correct setting on the digital display.
- ◆ Use the Fine/Coarse Switch for setting the appropriate time or current - this will toggle between 10th's and 100th's of a unit (seconds or amps), depending on whether you are setting Time or Current.
- ◆ There is a Chart (see below) of approximate settings for full-base diameter studs located to the left of the Controls.

DIA INCH	TIME SEC	AMPS DC	DIA DEC	DIA MM
1/4	0.200	500	.250	6.35
5/16	0.300	550	.312	7.93
3/8	0.350	600	.375	9.52
7/16	0.420	700	.437	11.11
1/2	0.500	900	.500	12.70
5/8	0.670	1200	.625	15.87
3/4	0.830	1600	.750	19.04
7/8	1.000	1800	.875	22.22
1	1.200	2100	1.000	25.40
APPROXIMATE SETTINGS FOR THRU-DECK WELDING				
3/4	.800 - 1.4	16-1900	.750	19.04
7/8	1.0 - 1.6	18-2200	.875	22.22

SC3400 Operations - Settings

Weld Counter and Weld Counter Reset

The SC3400 is equipped with different counters to display the number of times the unit has drawn an arc or the stud gun has been actuated.

Perpetual Weld Counter (Non-resettable) - This is a running total of every time an arc is drawn on the machine. This is programmed from the factory and can not be reset.

Perpetual Gun Counter (Non-resettable) - This is a running total of every time the stud gun is actuated whether an arc was drawn or not.

Job Counter (Resettable) - This is a running total of the number of welds since the counter was last reset. To view the job counter, set the Fine/Coarse Switch to the Fine position. Each weld will be recorded on the Current digital display. If the switch is in the Coarse position, the weld will still be counted, but will not be displayed. You can also view the Job Counter total by depressing the Adjustment Dial while the switch is in the Coarse position.

To Reset the Job Counter;

1. Turn off unit.
2. Depress and hold down Time and Current buttons.
3. Turn on machine.
4. Keep holding down buttons until OUTPUT light flashes then release the buttons.
5. Job Counter will now be set at 0.
6. Weld count will now register on Current digital display.

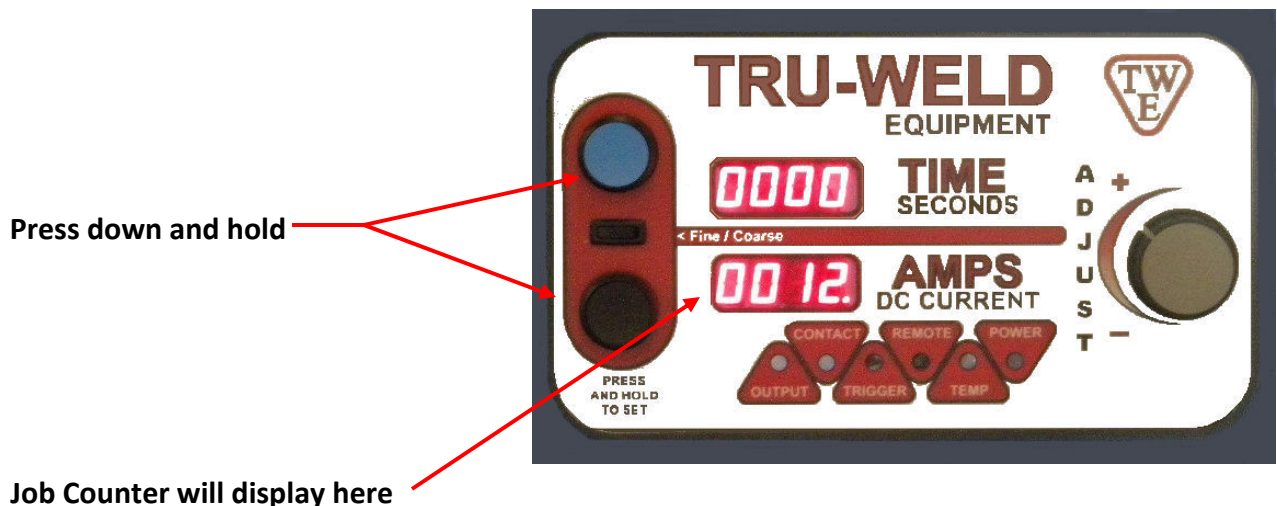

SC3400 Operations - Welding

Stud Welding - Step by Step

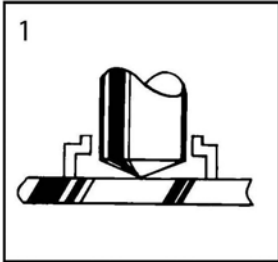

1 The weld gun is positioned over the base material and the main gun spring is partially compressed. Hold gun perpendicular to work surface and hold ferrule firmly against the surface.

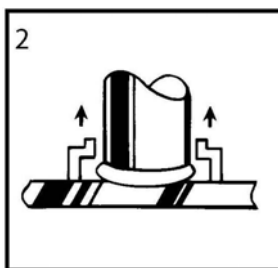

2 The trigger is pressed and the stud lifts off the base, drawing an arc. The arc melts the end of the weld stud and the base material below. The arc shield (ferrule) concentrates the heat below the weld stud and contains the molten metal within the weld zone. Do not move weld gun during weld.

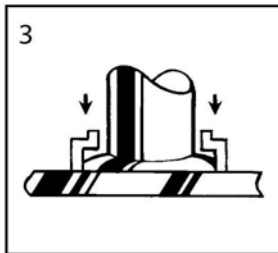

3 The main spring plunges the weld stud down into the molten pool of metal in the base material. The cycle is completed in less than a second and the resulting weld bond develops the full strength of the fastener in the weld zone. Allow metal to cool and withdraw gun from the stud, pulling the gun straight up off of the stud.

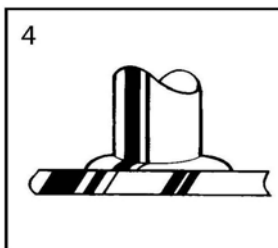

4 The weld gun is withdrawn from the weld stud leaving and the ferrule. The ferrule is broken away and discarded. Visually inspect weld.

*** Note - when determining finished length required for the particular application, keep in mind the reduction in length (burn-off) from stud welding operations. TRU-WELD stud lengths are always given before weld.

Diameter of Stud	Reduction in Length
1/4" thru 1/2"	1/8"
5/8" thru 7/8"	3/16"
1" and over	1/4"

SC3400 Operations - Welding

Stud Welding - Helpful Hints and Suggestions

- Keep weld studs and ferrules clean and dry.
- Set the time for the appropriate weld base diameter (see chart on page 19).
- Set the amperage for the appropriate weld base diameter (see chart on page 19).
- Make sure the negative polarity is to the weld stud gun and ensure a good, clean ground connection.
- Align accessories so they are centered and adjust legs so that 3/16" to 1/4" of the stud protrudes beyond the ferrule.
- Make sure work surface is relatively clean so impurities do not affect weld.
- Test the welds at the beginning of each shift or change in stud. Bend two studs 30 degrees after cooling (AWS Bend Test).
- Check burn off (1/8" – 3/16"), color (silver blue and shiny), and weld fillet (360 degree).
- Visually inspect all welds.

Thru-Deck Stud Welding - Helpful Hints and Suggestions

- Keep weld studs and ferrules clean and dry.
- Never attempt thru-deck welding when the ambient temperature is below 32°F
- Deck must be layered flat on supporting members.
- Deck must be properly grounded. Be sure all cable connections are tight and secure.
- Always use a special thru-deck type ferrule.
- Visually inspect all welds.

To ensure satisfactory welds, bend test a minimum of one stud out of every one-hundred, by striking stud with a hammer and bending the stud 15° from its original axis.

SC3400 Operations - Welding

Visual Weld Inspection and Adjustments

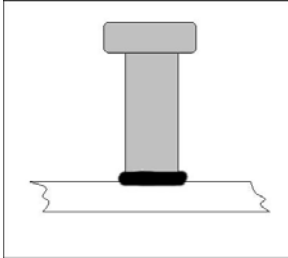

Good Weld

After shooting the stud, break away ferrule and visually inspect the weld. The collar should be smooth and even around the entire stud.

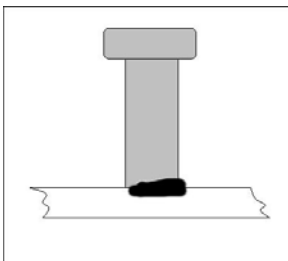

Partial Weld

This is when the collar does not extend around the entire perimeter of the base of the stud. This normally occurs when the weld power is set too low.

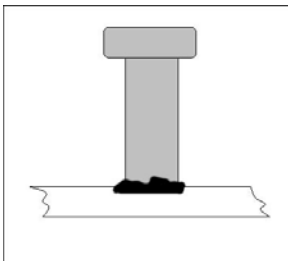

Irregular Weld

This is when the collar forms a bumpy or jagged collar around the base of the weld stud. This normally occurs when the weld time is set too high.

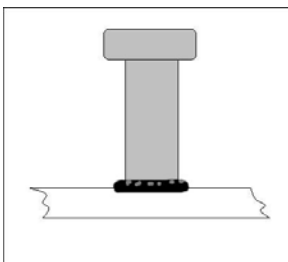

Porous Weld Collar

This usually occurs from the oxidation of the weld pool resulting from the weld time being set too long and/or the current being too low. Reduce the current and/or reduce the weld time to correct.

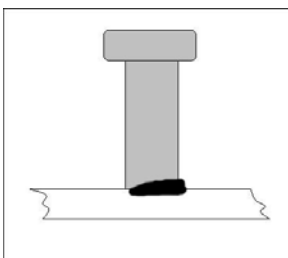

Weld Collar Off-Center

This is when the collar is heavy or thick on one half of the base of the weld stud. The stud may also be tilted. This usually results from movement from the gun during the weld process or the gun not being flush or perpendicular to the base material during welding.

SC3400 Troubleshooting

Problem	Possible Cause	Fix
Unit will not turn on.	No power.	<ol style="list-style-type: none"> 1. Test 3 phase power to control contactor. 2. Check taps (if applicable) on main transformer. 3. Check voltage selection plug near control transformer. 4. Check fuse located on control transformer. 5. Look for power available LED on control transformer. 6. Make these checks before contacting a TWE Rep.
Fan does not run when unit is turned on.	This is normal.	The fan will cycle on when the main bridge has reached nominal operating temperature. Ambient temperature of the weld site should also be taken in consideration.
Fan runs continuously (does not cycle on/off)	Thermostat circuit	A fault in the thermostatic circuit will cause the fan to run continuously. Call your TWE Rep for repairs.
Unit turns on, coil boot test is good, no trigger from weld gun.	Bad connection or faulty equipment.	<ol style="list-style-type: none"> 1. Test control cable by plugging weld tool directly into unit (4 conductor straight through wiring). 2. Check gun trigger resistance (<100 ohms when closed). 3. Check to see if trigger LED on control panel responds. 4. Check to see if weld tool is wired according to one of the three diagrams in Chart A (see page 25). 5. Locate Touch/Trigger Control Board #16002 (Chart B). Check and note the operation of the driver LED's and report the status.
Unit turns on, no coil test, no lift from gun coil, trigger is good.	Bad connection or faulty equipment.	<ol style="list-style-type: none"> 1. Test control cable by plugging weld tool directly into unit (4 conductor straight through wiring). 2. Check 10 amp fuse on control board box next to breakers. 3. Check hand tool coil resistance (12 - 40 ohms). 4. Locate Touch/Trigger Control Board #16001 (Chart B). Check and note the operation of the driver LED's and report the status.
Gun lifts, no weld arc drawn.	Bad connection or faulty equipment.	<ol style="list-style-type: none"> 1. Check connections for ground and weld tool leads. 2. Check if contact LED on control panel lights when stud is touched to work surface (closing circuit). 3. Check the two circuit breakers on the control board box. 4. Check to see if you have the sustaining arc (a small blue arc for the duration of the weld time). 5. Check to see if the stud sparks at the end of the weld cycle (hot plunge). 6. Locate Touch/Trigger Control Board #16001 (Chart B). Check and note the operation of the driver LED's and report the status.

SC3400 Troubleshooting

Problem	Possible Cause	Fix
Unit stops welding, OverTemp LED is on.	Over heating.	<ol style="list-style-type: none"> 1. If the fan is running, allow unit to cool. 2. Slow down welding rate (fewer studs per minute). 3. Any fault in the OverTemp Thermostat Circuit will shut the system down.
Weld output erratic or weak.	Adjustments or settings.	<ol style="list-style-type: none"> 1. Check welding hand tool set up, lift, plunge, and accessory adjustments. 2. Check ALL weld current carry leads and connections, including grounds. 3. Test the power loop by making welds on a test piece using only the starter cable set. 4. Test 3 phase power to control contactor. 5. Check taps (if applicable) on main transformer.
Weld gun lifts, but does not plunge.	Gun maintenance.	If this happens, it is most likely binding inside of the gun. Perform routine gun maintenance or replace gun if needed.

All tests should be performed by a qualified person.

Always turn off power to the welder before working on or testing components within the welder.

Contact your TRU-WELD Equipment Representative for replacement parts and for servicing your welding equipment.

SC3400 Troubleshooting

Chart A

Acceptable R&S Control Wire Schematics For Weld Tools

The Tru-Weld Equipment Digital Series Welders will accept any one of these configurations without changing any wiring in the machine.

SOCKET VIEW FROM UNIT

PLUG VIEW FROM GUN

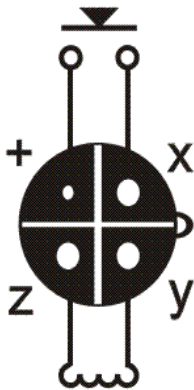

TRU-WELD 4 WIRE
(PREFERRED)
+ - TRIGGER
x - TRIGGER
y - COIL
z - COIL

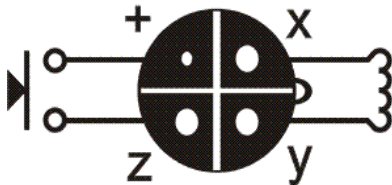
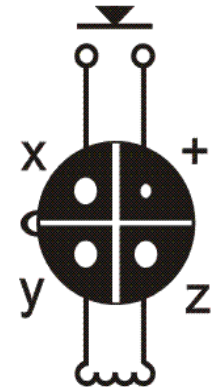

PROWELD / KSM 4 WIRE
+ - TRIGGER
x - COIL
y - COIL
z - TRIGGER

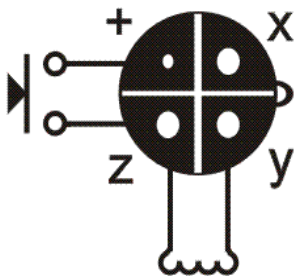
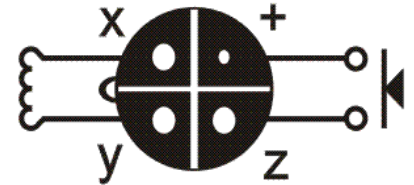

TRW / NELSON 3 WIRE
+ - TRIGGER
x - NOT USED
y - COIL
z - COIL AND TRIGGER

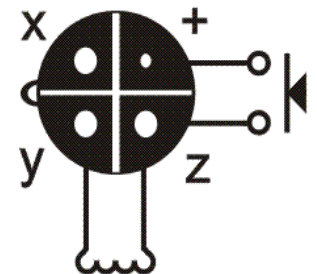

When making your own tool extensions 16/4 cable is recommended.

NOTE: Make sure the ground pin (+) is isolated from the case.

Contact Tru-Weld Equipment with any questions on connections.

SC3400 Troubleshooting

Chart B

Circuit board, control box, fuse, breaker and L.E.D. layout

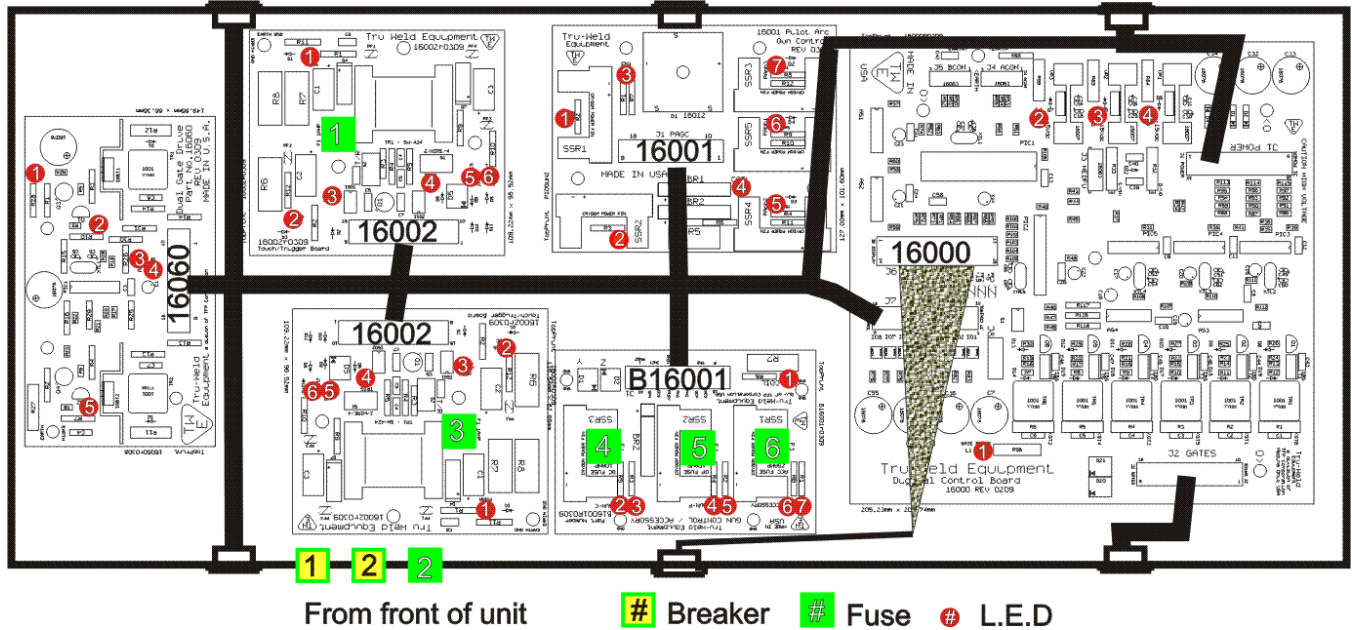

Board	16000	16001	16002	B16001	16060
Name	Digital Control	Pilot Arc Gun Control	Touch / Trigger	Gun Control Accessory	Dual Gate Drive
LED 1	L1- Gate Power	GPri - SSR1	L1 - PWRA - F1,3	LG4 - COIL	Yellow
	36 Volt Supply	Gun Primary	Touch Supply	YZ Output	+15 Vdc Supply
LED 2	L2- +5Vdc	GSec - SSR2	L6 - +5VDC	LG3 - GUN-C	RED - Q1
	Pos 5V Supply	Gun Secondary	Digital Supply	GLV Signal	TR1 Active
LED 3	L3- +15Vdc	LR6 - PA	L2 - WORK	LR3 - GUN-C	A - GREEN
	Pos 15V Supply	D1 Pilot Arc Output	Stud On Work Indicator	GC FUSE Indicator	Channel A Selected
LED 4	L4- -15Vdc	LR4 - COIL	L3 - TRIG	LG2 - GUN-P	B - GREEN
	Neg 15V Supply	BR1,2 Output	Trigger Indicator	GHV Signal	Channel B Selected
LED 5		LG1 - Paph2	L5 - 2WIRE	LR2 - GUN-P	RED Q2
		Drive Signal	Input #2 Supply	GP FUSE Indicator	TR2 Active
LED 6		LR5 - Paph1	L4 - 4WIRE	LG1 - ACCESS	
		Drive Signal	Input #1 Supply	ACC Signal	
LED 7		LR1 - Paph3		LR2 - ACCESS	
		Drive Signal		ACC FUSE Indicator	
FUSE		F2	F1,3	F4-6	
		AGC 10A 250V ¼ X 1¼ Hand Tool 1 Coil	1A 125V FST 5 X 20 mm LED 1 PWRA	10A 250V FST 5 X 20 mm Hand Tool 2 Coil	
BREAKER	BKR 1,2				

SC3400 Parts and Accessories

TRU-WELD Equipment manufactures and stock a full line of stud welding parts and accessories for all of your stud welding needs (most accessories listed below are for 3/4" and larger studs).

Closed Ferrule Grips (1" Long) Brass		Split Ferrule Grip (1" Long) Brass	
Stud Diameter	Part Number	Stud Diameter	Part Number
3/4	GN-075	3/4	GC-075
7/8	GN-087	7/8	GC-087
1	GN-100	1"	GC-100
Adjustable Chucks		Headed Chucks	
Stud Diameter	Part Number	Stud Diameter	Part Number
3/4	CN-075	3/4	CH-075
7/8	CN-087	7/8	CH-087
1"	CN-100	1"	CH-100
Gun Legs		Thru-Deck Accessories	
Length & Diameter	Part Number	Description	Part Number
7" (5/16 Diam.)	L-03107	Thru-Deck Foot Assembly	B-0021
9" (5/16 Diam.)	L-03109	Foot Only	B-0021-1
14" (5/16 Diam.)	L-03114	Extension Bar	B-0021-2
18" (5/16 Diam.)	L-03118	Screws	B-0021-3
7" (3/8 Diam.)	L-03707	Thru-Deck Ferrule Holder	Part Number
9" (3/8 Diam.)	L-03709	3/4 WTD/ 7/8 Flat	B-0060-1
14" (3/8 Diam.)	L-03714	3/4 Flat	B-0060-2
18" (3/8 Diam.)	L-03718	5/8 Flat	B-0060-3
24" (3/8 Diam.)	L-03724	1" Flat	B-0060-4
27" (3/8 Diam.)	L-03727	1/2 Flat	B-0060-5
32" (3/8 Diam.)	L-03732	Twin Leg Ferrule Foot Plates	
36" (3/8 Diam.)	L-03736	Diameter	Part Number
48" (3/8 Diam.)	L-03748	1/4	QN-025
Gun Feet		5/16	QN-031
Closed 1/4 - 1/2	B-1N	3/8	QN-037
Closed 5/8 - 3/4	B-2N	1/2	QN-050
Closed 7/8 - 1"	B-3N	5/8	QN-062
Split 1/4 - 1/2	B-1C	3/4	QN-075
Split 5/8 - 3/4	B-2C	7/8	QN-087
Split 7/8 - 1"	B-3C	1"	QN-100

TRU-WELD Equipment Company

6400 N. Honeytown Road

Smithville, Ohio 44677

(330) 669-2773 Phone

(330) 669-2473 Fax

TWE@tfpcorp.com

<http://truweldstudwelding.com>



MADE IN THE USA